

SANISTATION®

INFECTION CONTROL THAT WORKS IN HEALTHCARE

WWW.SANI-STATION.CO.UK



INFECTION CONTROL THAT WORKS WITH YOU

From the unique face mask dispenser, to the mobile infection control units and period products dispenser, SaniStation[®] has grown and is now embedded into the long-term IPC strategy of many healthcare providers across the UK and Ireland. Working with senior nurses and IPC teams we have developed a range that meets the very highest hygiene standards. By maximising sanitisation and minimising opportunities for cross-contamination, SaniStation[®] is helping to protect patients, healthcare staff and all site users.



MADE IN BRITAIN



BRANDED



BESPOKE SOLUTIONS

CONTENTS

Face Mask Dispenser	04
Compact Face Mask Dispenser	06
Anti-ligature Face Mask Dispenser (Patent Pending)	08
Mobile Infection Control Unit	10
Wall-mounted Infection Control Unit	12
Accessories	14
SaniStation Hub [®]	16
SaniStation Hub [®] with Glove Shield™	18
High Capacity Period Products Dispenser	20
Compact Period Products Dispenser	22
Multi Period Products Dispenser	24

A healthcare professional, likely a nurse or doctor, is shown in profile, wearing a light blue surgical mask and a matching scrubs uniform. She has a stethoscope around her neck and is looking intently at a computer monitor. Her hands are on a mouse, suggesting she is working at a workstation. The background is a blurred clinical setting. The overall image has a dark, blue-tinted overlay.

INFECTION CONTROL
THAT WORKS
IN HEALTHCARE

FACE MASK DISPENSER

IDEAL FOR ACCESS POINTS & WAITING AREAS.

Unique to SaniStation[®], the robust mask dispenser is ideal for healthcare environments, dispensing essential PPE at access points, receptions, waiting areas and other areas of high footfall.

The simple dispensing mechanism, minimises waste and helps to reduce petty theft. When the unit needs to be refilled, replenishing stocks is quick and easy.

Developed in conjunction with a number of NHS trusts, the unit limits opportunities for cross-contamination of PPE, helping to maintain your hygiene levels and keep staff and visitors safe.

As with most products in the SaniStation[®] range, the Face Mask Dispenser can be branded to suit your healthcare organisation's corporate identity.

- ✓ Hygienic and easy to clean
- ✓ Reduces waste by dispensing one mask per user
- ✓ Saves time on refilling
- ✓ 250+ mask capacity
- ✓ Robust and secure steel construction
- ✓ Compatible with most disposable masks
- ✓ Ideal for access points & waiting areas
- ✓ Dimensions (mm): 474h x 207w x 113d

PRODUCT	CODE
Face Mask Dispenser	SaniFMD1
Face Mask Dispenser with vision panel	SaniFMD1vp

NOW AVAILABLE WITH A REFILL VISION PANEL

Flush glazed vision slot for ease of stock monitoring without removing the cover

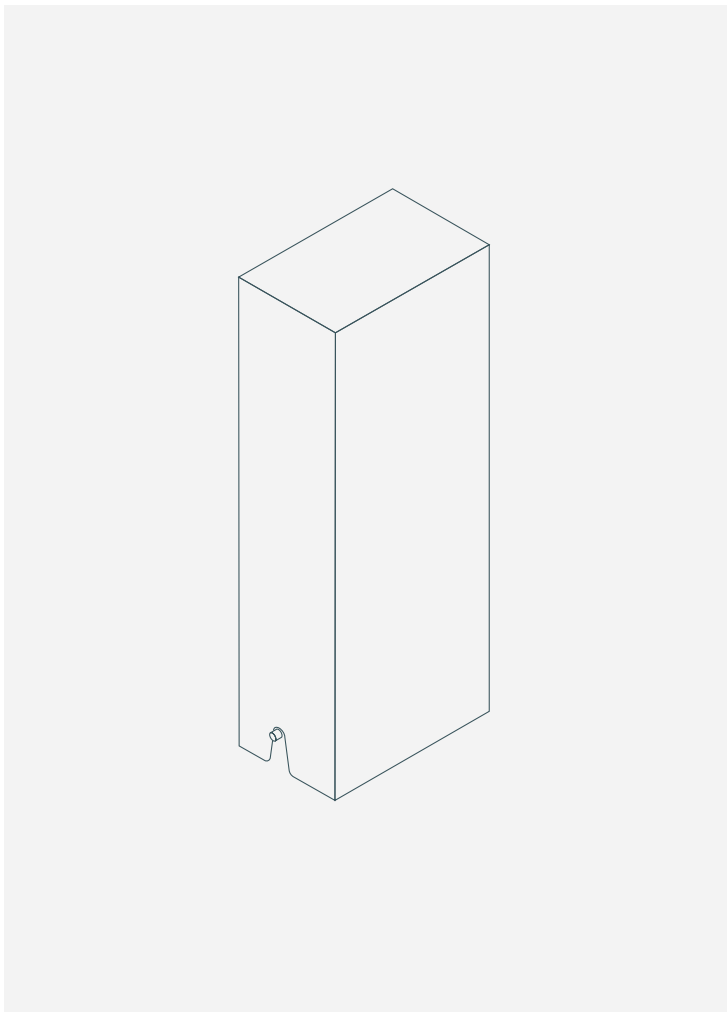
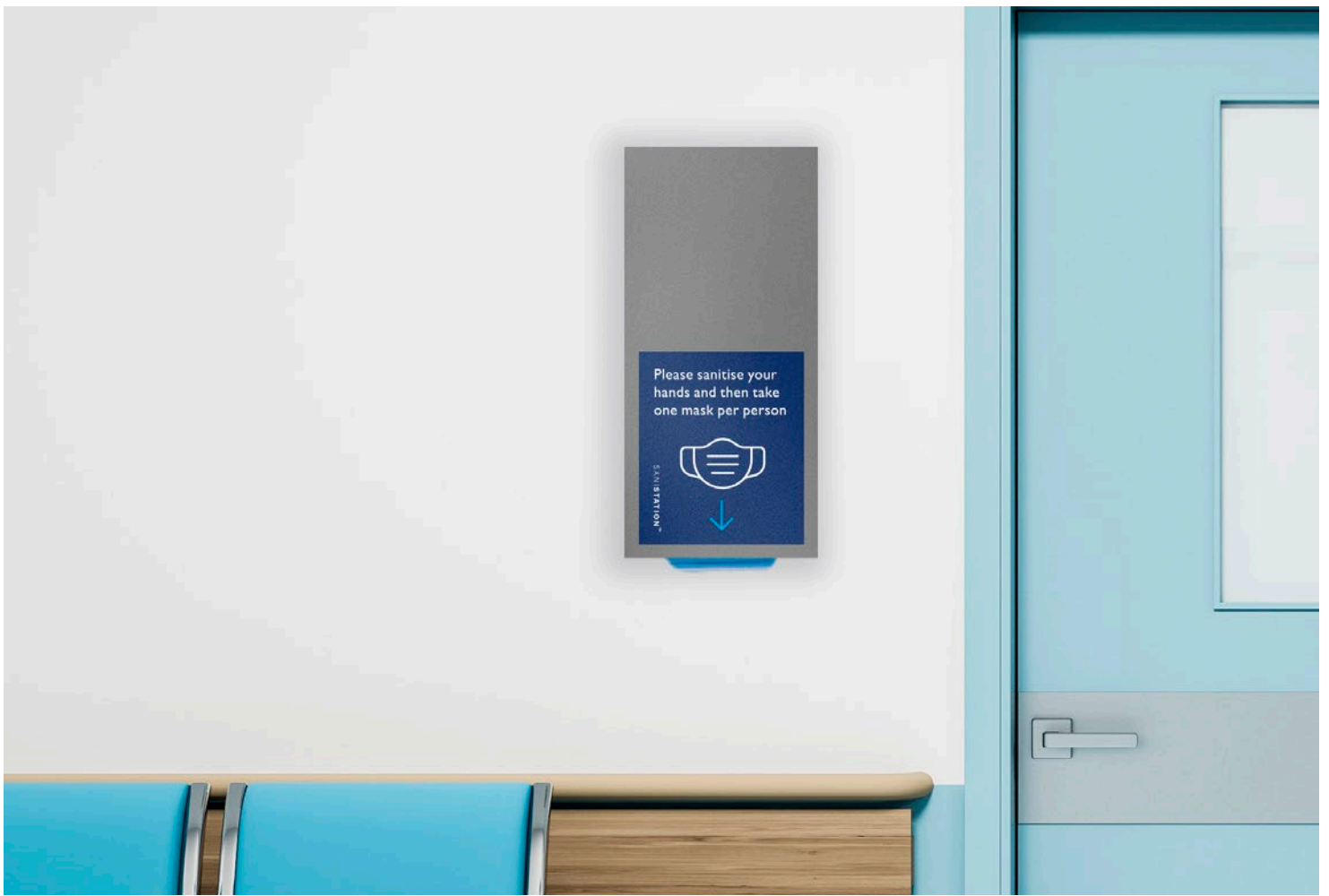

COMPACT FACE MASK DISPENSER

SUITABLE FOR PROCEDURE & CONSULTING ROOMS.

Unique face mask dispenser with capacity for over 100 masks. Perfect for procedure and consulting rooms where the enclosed storage of PPE is essential to avoid cross-contamination.

As with most products in the SaniStation® range, the Compact Face Mask Dispenser can be branded to suit your healthcare organisation's corporate identity.

- ✓ Space saving size
- ✓ Fully enclosed design suitable for procedure and consulting rooms
- ✓ Hygienic and easy to clean
- ✓ 100+ disposable face mask capacity
- ✓ Reduces cross-contamination - only touch the mask you're going to wear
- ✓ Reduces waste by dispensing one mask per user
- ✓ Robust and secure steel construction
- ✓ Dimensions (mm): 230h x 207w x 113d

PRODUCT	CODE
Compact Face Mask Dispenser	SaniFMD2

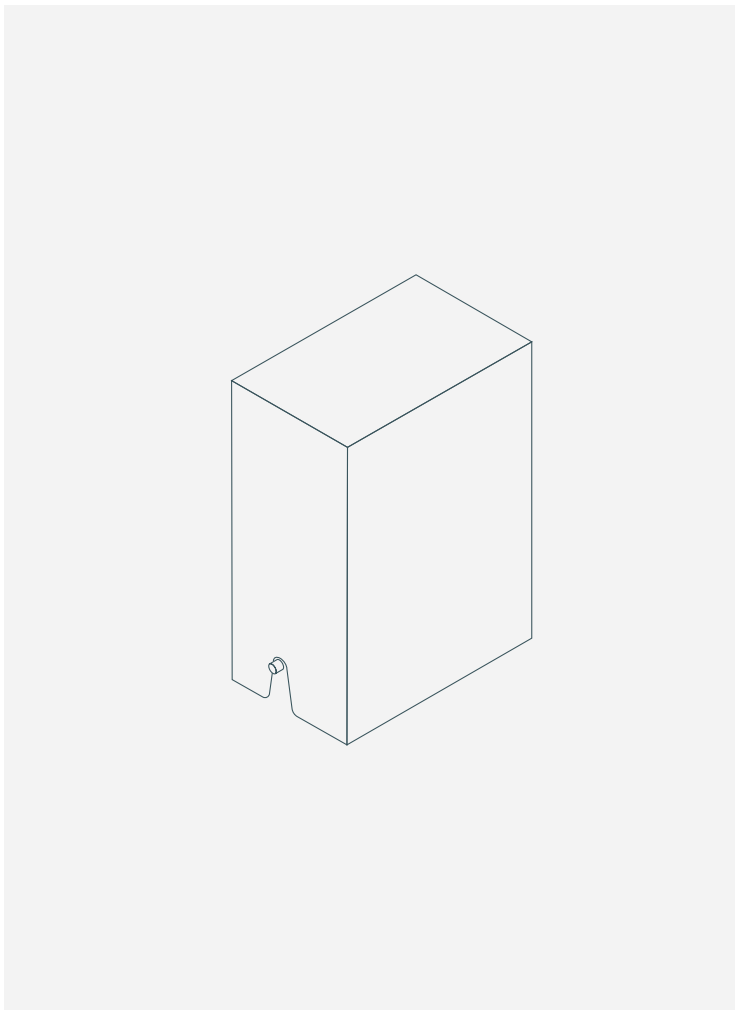
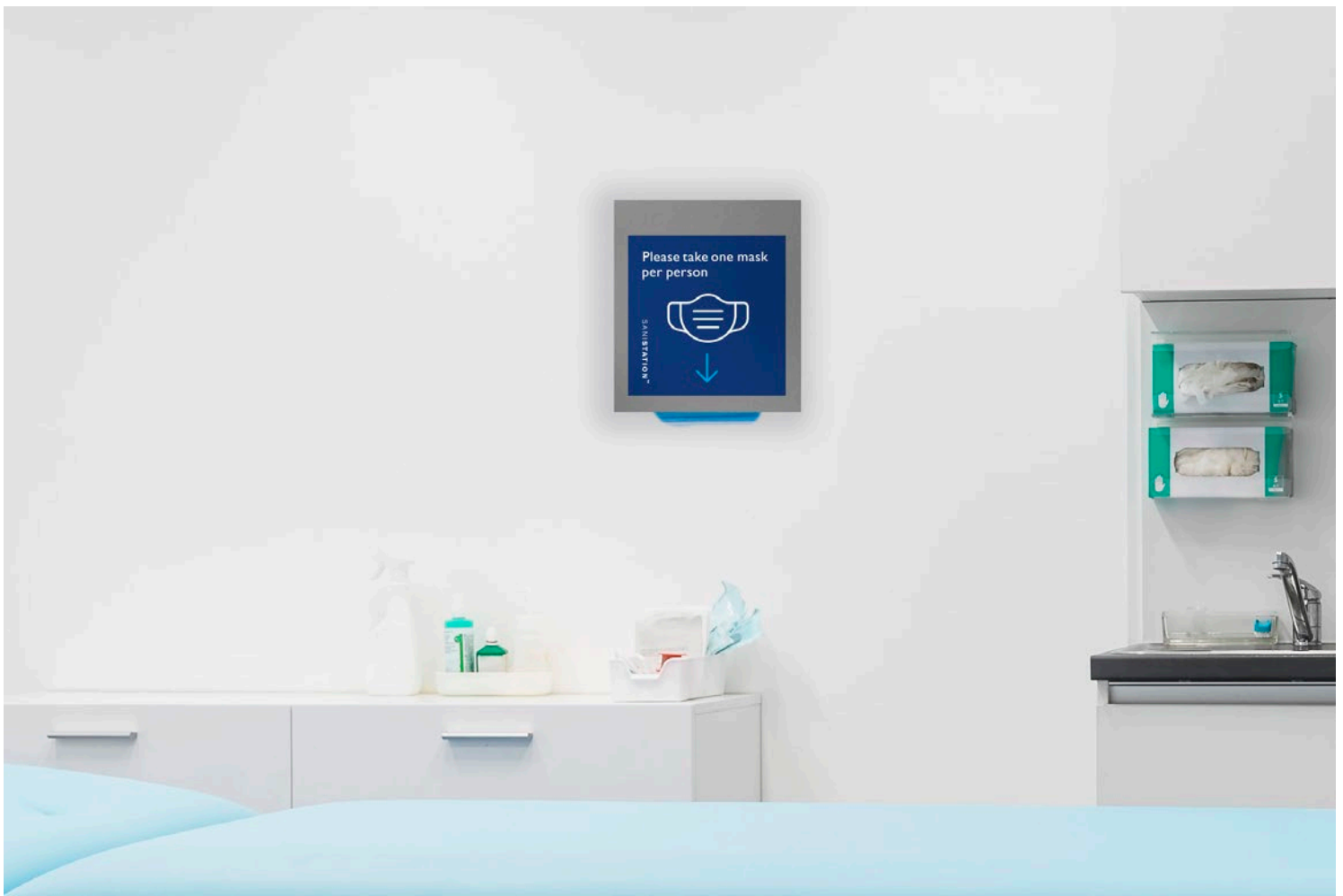

ANTI-LIGATURE FACE MASK DISPENSER

THE SAFE PROVISION OF FACE MASKS IN MENTAL
HEALTH OR SPECIAL CARE ENVIRONMENTS.

The Anti-ligature Face Mask Dispenser is designed for any mental health or special care environment looking after vulnerable individuals.

The wall-mounted unit has minimal ligature points and can be sealed on all edges to close off any gaps between the unit and the wall.

The dispensing cassette is locked in a closed position and can be unlocked to allow replenishment. This product can also be used in environments where PPE needs to be available for care givers, but where it's not safe for patients to help themselves (i.e. dementia patients).

Call us to discuss your specific requirements.

- ✓ Minimises risk of self-harm
- ✓ Hygienic and easy to clean
- ✓ Reduces cross contamination
- ✓ Complies with all IPC protocols
- ✓ Robust and secure metal construction
- ✓ Concealed multi-point wall plate fitting
- ✓ Brandable with your logos and messaging
- ✓ Dimensions (mm): 430h x 207w x 122d

PRODUCT	CODE
Anti-lig Face Mask Dispenser	SaniAntiligMaskDispenser

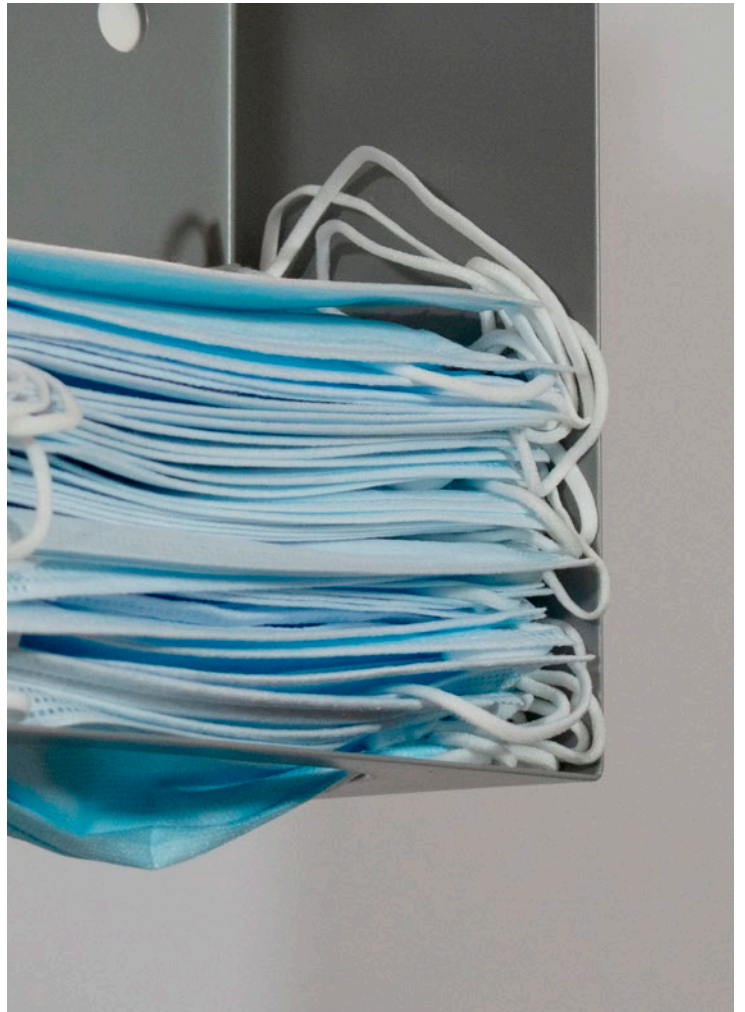
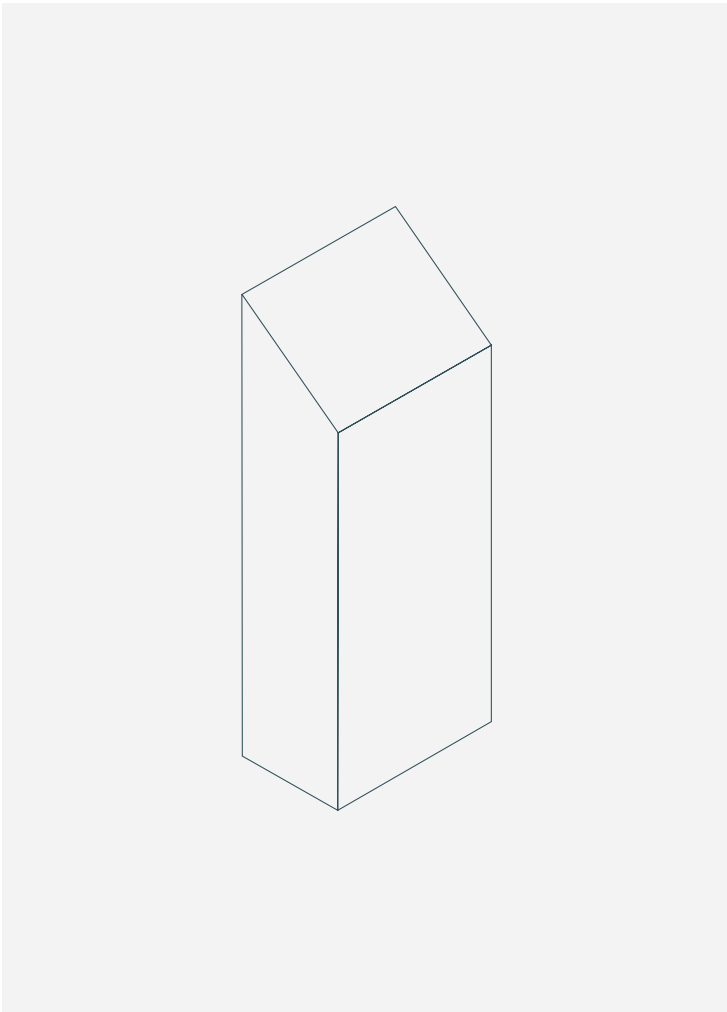

MOBILE INFECTION CONTROL UNIT

IDEAL FOR ENTRANCES, HIGH TRAFFIC AREAS & WARDS.

This single or double-sided unit is ideal for building entrances, high-traffic areas and wards. The Mobile Infection Control Unit provides a unique opportunity to design the perfect highly visible solution to specific IPC scenarios across your site.

Designed to ensure all site users comply with mandatory sanitisation and personal protection regimes, these heavy duty units are now hugely popular across the UK & Ireland.

As with most products in the SaniStation® range, the Mobile Infection Control Unit can be branded to suit your healthcare organisation's corporate identity.

- ✔ Save space with minimal footprint
- ✔ Single or double-sided
(Choose single-sided for a smaller footprint)
- ✔ Easy-clean back panel
- ✔ Bespoke printed for communicating key messages
- ✔ Accessorise to your specific IPC requirement
- ✔ Mobile and versatile

PRODUCT	CODE
Mobile Infection Control Unit - single sided	SaniHD4
Mobile Infection Control Unit - double sided	SaniHD2
ACCESSORY	CODE
Mobile Infection Control Unit - single sided	SaniHD4
Mobile Infection Control Unit - double sided	SaniHD2
Face Mask Dispenser	SaniFMD1
Face Mask Dispenser – with vision panel	SaniFMD1vp
Compact Face Mask Dispenser	SaniFMD2
Visor Trough	SaniVisorTrough
Thermometer Holder	SaniThermoHolder
Wipes Holder	SaniWipesHolder
Gloves Dispenser	SaniGlovesDispenser
Drinks Bottle Holder	SaniBottleHolder
Apron Dispenser	SaniApronDispenser
Gown Holder	SaniGownHolder
Drawer Unit	SaniDrawer
Manual Gel Dispenser*	ManualDispenser
Manual Dispenser Drip Tray	ManualDispenserDripTray
Shelf Standard	SaniShelf
A4 Clip Frame	A4ClipFrame
Pedal Bin – 45L Grey	SaniPBin45G
Pedal Bin – 45L Yellow	SaniPBin45Y
Pedal Bin – 87L Grey	SaniPBin87G
Pedal Bin – 87L Yellow	SaniPBin87Y

*We regularly fit our clients' own Gel Dispensers – speak to one of our team to arrange.

We've helped customers design multiple versions of their Mobile SaniStations for specific uses across their hospitals. For example; masks and hand gel accessories for entrance units and visor troughs, wipes dispensers and bottle holders forward units.

If you can't see an accessory that would fulfil your requirement please let us know and we can work to design something bespoke for you.



WE MANUFACTURE EVERY SANISTATION® MOBILE INFECTION CONTROL UNIT TO OUR CUSTOMERS' REQUIREMENTS.

1.

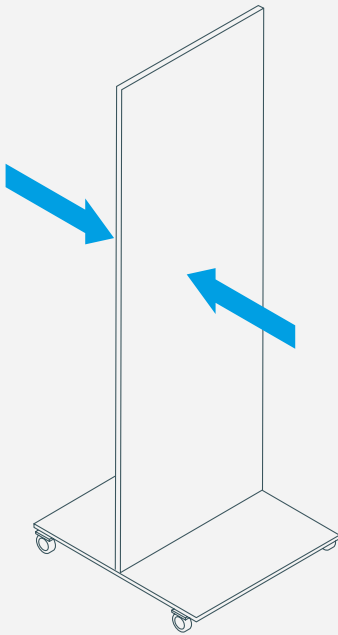

SELECT SINGLE OR DOUBLE SIDED

Start by determining if you need a single or double sided mobile unit.

2.

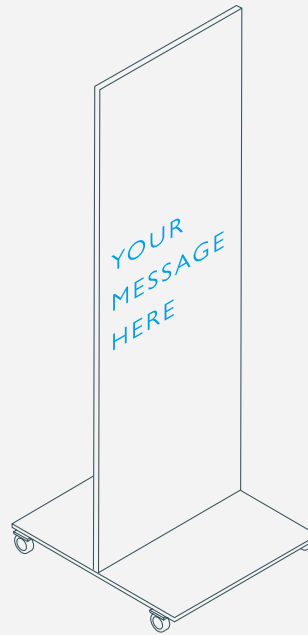

DESIGN YOUR MESSAGING

Add your branding or IPC messaging to the large, easy-clean panel(s).

3.

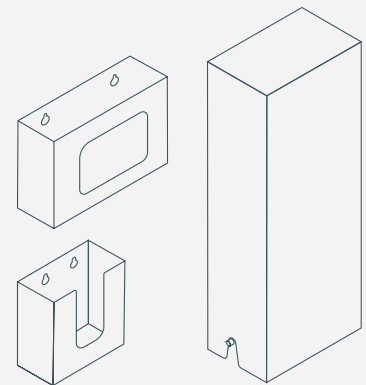

CHOOSE YOUR ACCESSORIES

Select from our comprehensive range of proven accessories to configure a SaniStation® unit suitable for your needs.

WALL-MOUNTED UNIT

IDEAL FOR LOCATING IN CORRIDORS, ASSESSMENT ROOMS & PRIVATE WARDS WHERE SPACE IS LIMITED.

The Wall-mounted SaniStation® is designed for building entrances and access points. The highly visual unit helps to protect site visitors, staff and patients, by providing easy and secure access to essential sanitisation materials and PPE. The wall-mounted unit facilitates site management best practice and saves staff time by reducing the need to monitor site entrances. As with most products in the SaniStation® range, this wall-mounted unit can be branded to suit your healthcare organisation's corporate identity.

- ✔ Available in three sizes:
 - MINI size - 600 x 800mm
 - MIDI size - 600 x 1200mm
 - MAXI size - 600 x 1700mm
- ✔ Easy-clean back panel
- ✔ Highly visible bespoke print
- ✔ Accessorise to your specific IPC requirements

PRODUCT	CODE
Wall Mounted MINI	SaniMINI600x800
Wall Mounted MIDI	SaniMIDI600x1200
Wall Mounted MAX	SaniMAX1600x1700
ACCESSORY	CODE
Face Mask Dispenser	SaniFMD1
Face Mask Dispenser – with Vision Panel	SaniFMD1vp
Compact Face Mask Dispenser	SaniFMD2
Visor Trough	SaniVisorTrough
Thermometer Holder	SaniThermoHolder
Wipes Holder	SaniWipesHolder
Gloves Dispenser	SaniGlovesDispenser
Drinks Bottle Holder	SaniBottleHolder
Apron Dispenser	SaniApronDispenser
Manual Gel Dispenser*	ManualDispenser
Manual Dispenser Drip Tray	ManualDispenserDripTray
Shelf Standard	SaniShelf
A4 Clip Frame	A4ClipFrame

*We regularly fit our clients' own Gel Dispensers – speak to one of our team to arrange.

We've helped customers design multiple versions of their Wall-Mounted SaniStations for specific uses across their hospitals. For example; masks and hand gel accessories or entrance units and visor troughs, wipes dispensers and bottle holders for ward units.

If you can't see an accessory that would fulfil your requirement please let us know and we can work to design something bespoke for you.



WE MANUFACTURE EVERY SANISTATION® WALL-MOUNTED UNIT TO YOUR CUSTOMERS' REQUIREMENTS.

1.

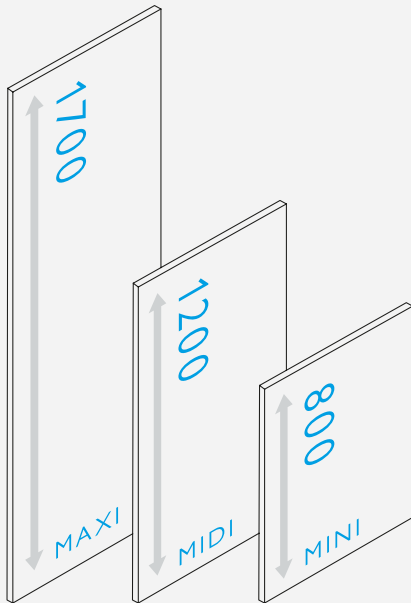

SELECT MAXI, MIDI OR MINI DIMENSIONS

Start by determining if you need a Maxi, Midi or Mini back panel, or double sided mobile unit.

2.

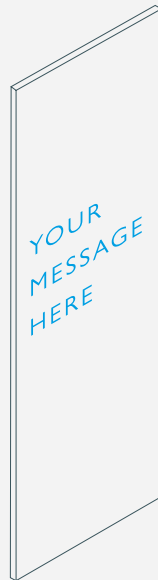

DESIGN YOUR MESSAGING

Add your branding or IPC messaging to the easy-clean back panel.

3.

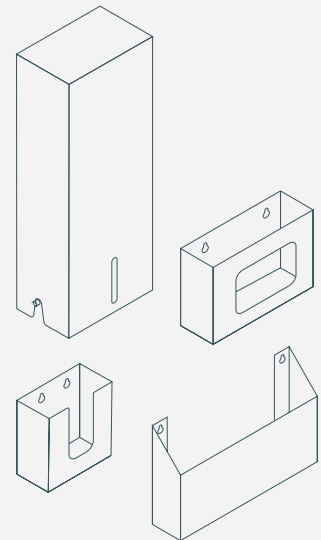

CHOOSE YOUR ACCESSORIES

Select from our comprehensive range of proven accessories to configure a SaniStation® unit suitable for your needs.

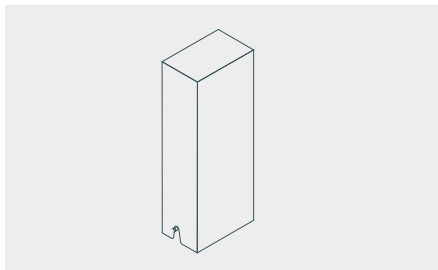

FACE MASK DISPENSER

- ✔ Hygienic and easy clean
- ✔ 250+ mask capacity
- ✔ Compatible with most disposable masks
- ✔ Ideal for access points & waiting areas

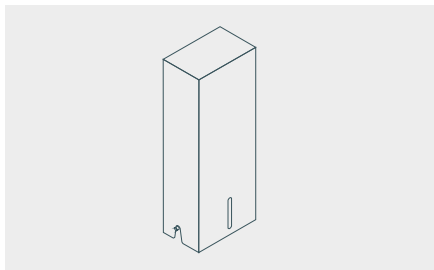

FACE MASK DISPENSER VP

- ✔ Hygienic and easy clean
- ✔ 250+ mask capacity
- ✔ Compatible with most disposable masks
- ✔ Ideal for access points & waiting areas
- ✔ Includes Vision Panel for easy stock monitoring

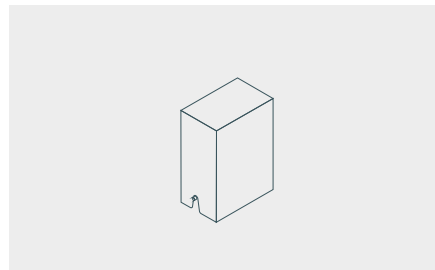

COMPACT FACE MASK DISPENSER

- ✔ Hygienic and easy clean
- ✔ 100+ mask capacity
- ✔ Compatible with most disposable masks
- ✔ Ideal for procedure & consulting rooms

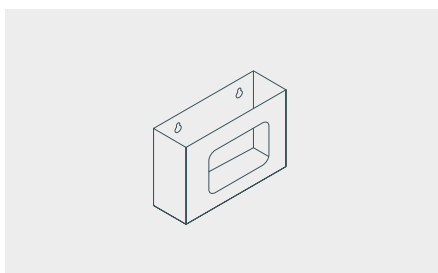

WIPES HOLDER

- ✔ For dispensing standard 200 pack wipes
- ✔ Fits Mobile Infection Control Unit, wall-mounted units or direct to wall

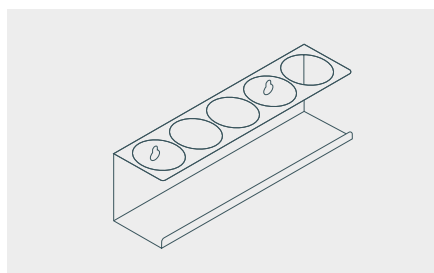

DRINKS BOTTLE HOLDER

- ✔ With 5 bottle capacity
- ✔ Fits to face or rear of Mobile Infection Control Unit, wall-mounted units or direct to wall

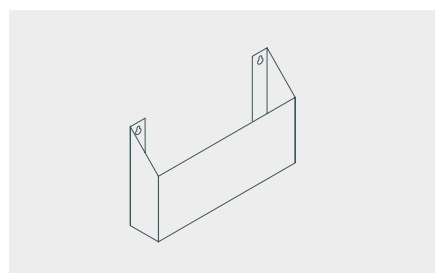

VISOR TROUGH

- ✔ For holding flat pack face shields
- ✔ Useful for folders and clip boards
- ✔ Fits Mobile Infection Control Unit, wall-mounted units or direct to wall

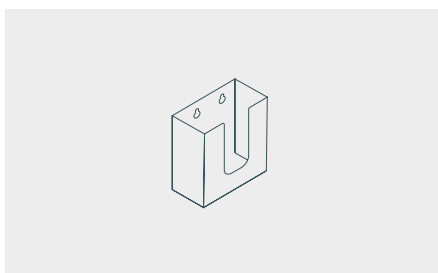

THERMOMETER HOLDER

- ✔ Fits up to 2 digital thermometers and cases
- ✔ Easy clean design
- ✔ Fits Mobile Infection Control Unit, wall-mounted units or direct to wall

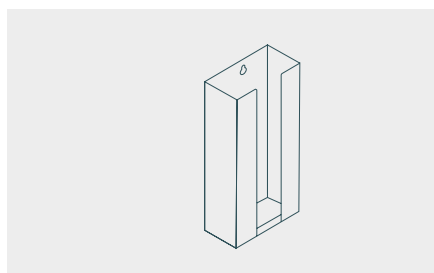

GLOVES DISPENSER

- ✔ Three box gloves dispenser
- ✔ Fits Mobile Infection Control Unit, wall-mounted units or direct to wall

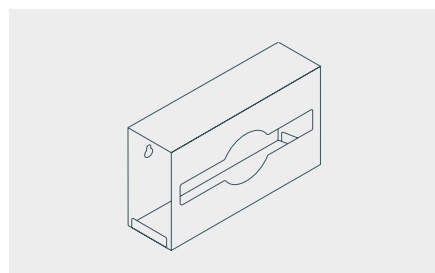

APRON DISPENSER

- ✔ Heavy duty apron roll dispenser
- ✔ Fits Mobile Infection Control Unit, wall-mounted units or direct to wall

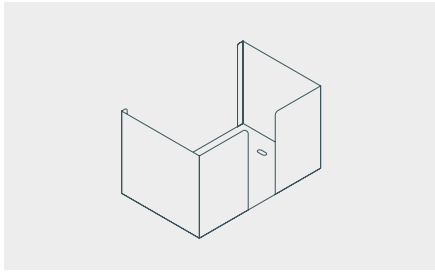

GOWN HOLDER

- ✔ Holder for large gown packs
- ✔ Fits Mobile Infection Control Unit

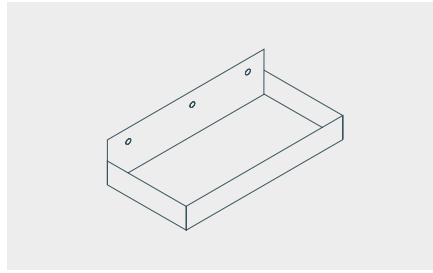

STANDARD SHELF

- ✔ Straight metal shelf with edge upstand
- ✔ Designed to hold up to 2 glove or mask boxes

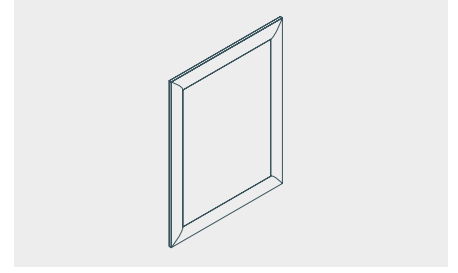

A4 CLIP FRAME

- ✔ For displaying important/changing information
- ✔ Fits Mobile Infection Control Unit or Wall-mounted Units

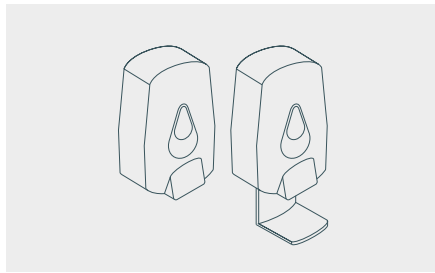

MANUAL GEL DISPENSER (800ML) MANUAL DISPENSER DRIP TRAY

Use our dispensers or supply your own dispensers.
Auto Gel Dispenser also available.

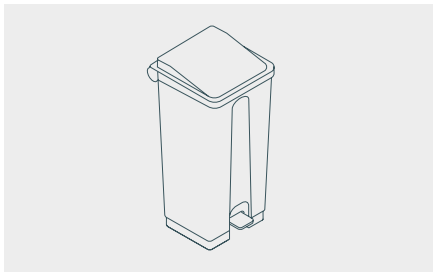

PEDAL BIN – 45L & 87L

- ✔ Pedal operated plastic bin
- ✔ Available in Grey and Yellow in two sizes
- ✔ Fits Mobile Infection Control Unit

ACCESSORY	CODE
Face Mask Dispenser	SaniFMD1
Face Mask Dispenser – with vision panel	SaniFMD1vp
Compact Face Mask Dispenser	SaniFMD2
Visor Trough	SaniVisorTrough
Thermometer Holder	SaniThermoHolder
Wipes Holder	SaniWipesHolder
Gloves Dispenser	SaniGlovesDispenser
Drinks Bottle Holder	SaniBottleHolder
Apron Dispenser	SaniApronDispenser
Gown Holder	SaniGownHolder
Drawer Unit	SaniDrawer
Manual Gel Dispenser*	ManualDispenser
Manual Dispenser Drip Tray	ManualDispenserDripTray
Shelf Standard	SaniShelf
A4 Clip Frame	A4ClipFrame
Pedal Bin – 45L Grey	SaniPBin45G
Pedal Bin – 45L Yellow	SaniPBin45Y
Pedal Bin – 87L Grey	SaniPBin87G
Pedal Bin – 87L Yellow	SaniPBin87Y

SANISTATION HUB®

IDEAL FOR CONSULTATION ROOMS, PRIVATE ROOMS AND GENERAL WARD USE, THE COMPACT WALL-MOUNTED SANISTATION HUB® MAKES CORE PPE AVAILABLE IN ONE PLACE.

The SaniStation Hub® has been designed in response to post-Covid PPE requirements. You can now dispense gloves, aprons AND masks all in one place in a compact unit which takes up no more wall width than a Danicentre.

- ✓ Easy to use - top hinged hood for easy replenishment
- ✓ Robust - metal construction
- ✓ Simple closure - no catches to break
- ✓ Brandable - option to include your branding or messaging
- ✓ Gloves - capacity for 3 boxes (i.e. small, medium & large.)
- ✓ Aprons - easy dispensing from a roll
- ✓ Masks - hygienic and high-capacity dispensing design
- ✓ Dimensions (mm): 565h x 468w x 145d

PRODUCT	CODE
SaniStation Hub®	SaniHub

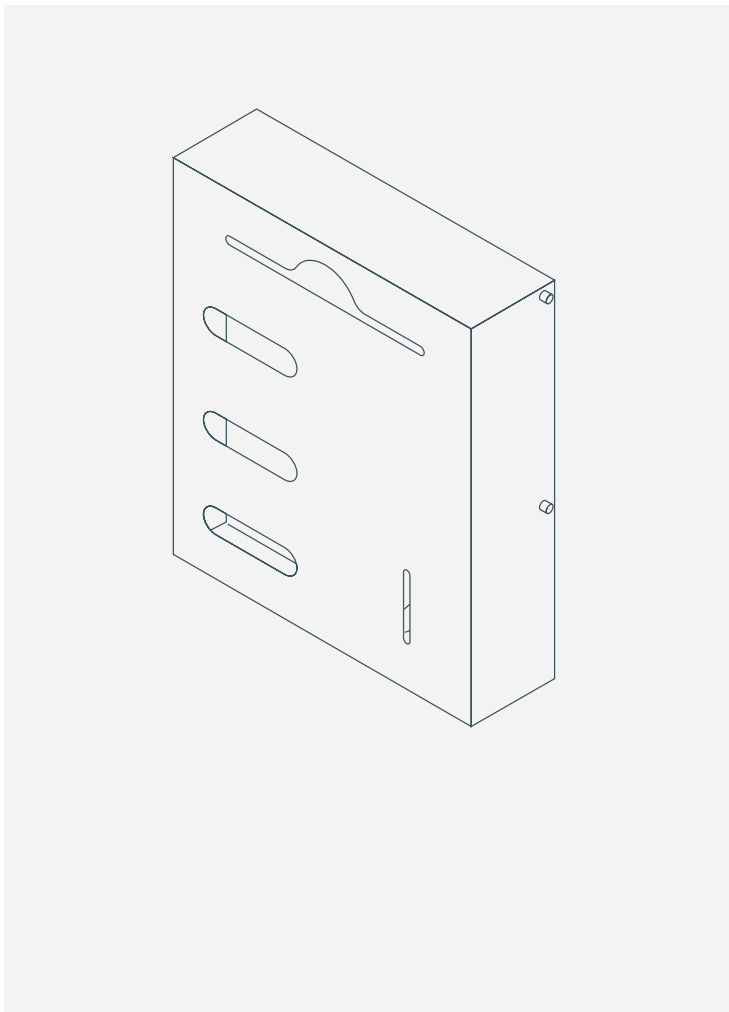

SANISTATION HUB® WITH GLOVE SHIELD™

IDEAL FOR SAFER PPE DISPENSING IN DEMENTIA CARE ENVIRONMENTS. THE COMPACT WALL-MOUNTED SANISTATION HUB® MAKES CORE PPE AVAILABLE IN ONE PLACE.

The SaniStation Hub® with Glove Shield™ has been designed in response to post-Covid PPE requirements. You can now dispense gloves, aprons AND masks all in one place in a compact unit which takes up no more wall width than a Danicentre.

- ✓ Safer dispensing – gloves cannot be accessed without lifting the shield
- ✓ Easy to use – top hinged hood for easy replenishment
- ✓ Robust – metal construction
- ✓ Simple closure – no catches to break
- ✓ Brandable – option to include your branding or messaging
- ✓ Gloves – capacity for 3 boxes (i.e. small, medium & large.)
- ✓ Aprons – easy dispensing from a roll
- ✓ Masks – hygienic and high-capacity dispensing design
- ✓ Dimensions (mm): 565h x 468w x 145d

PRODUCT	CODE
SaniStation Hub® – with Glove Shield™	SaniHub GS

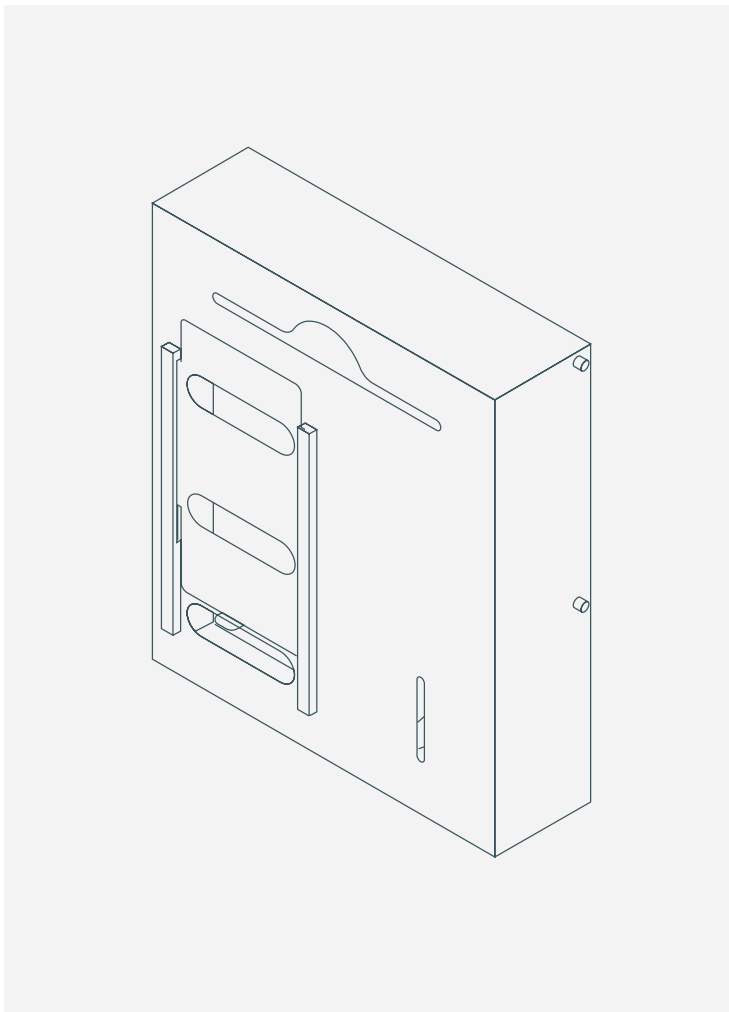

PPD 2

A HIGH-CAPACITY FREE VEND DISPENSER. DISPENSES TAMPONS AND PADS. OFTEN LOCATED CENTRALLY IN LARGER WASHROOMS WITH HIGH FOOT FALL. THE SAFE PROVISION OF SANITARY PADS AND TAMPONS.

The Period Products Dispenser was born from working closely with NHS Scotland on their Period Poverty campaign. The brief was to design a free-dispense solution that makes sanitary products available in a way that limits cross contamination, waste and theft. The simple dispensing mechanism allows for one pad or tampon to be taken at a time whilst minimising the chance of contaminating the next product in the dispenser. The fully enclosed unit is very easy to clean and complies with all IPC protocols, it's also very quick to assess stock and simple to refill. As with most products in the SaniStation[®] range, the Period Products Dispenser can be branded to suit your healthcare organisation's corporate identity.

- ✓ High Capacity
- ✓ Free dispense – no coins or tokens required
- ✓ Simple to install – no electrical supply required
- ✓ Hygienic and easy to clean
- ✓ Minimises cross contamination
- ✓ Complies with all IPC protocols
- ✓ Easy to monitor stock and refill
- ✓ Dispenses a wide range of tampons and pads
- ✓ Reduces waste and theft
- ✓ Robust and secure metal construction
- ✓ Brandable with your logos and messaging
- ✓ Dimensions (mm): 474h x 280w x 132d
- ✓ Weight (kg): 6.2

PRODUCT	CODE
Period Products Dispenser	SaniPPD2

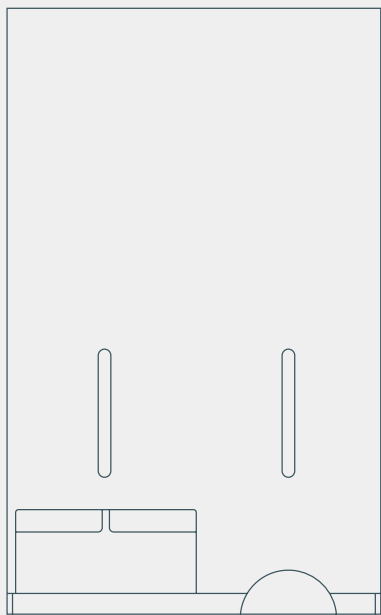
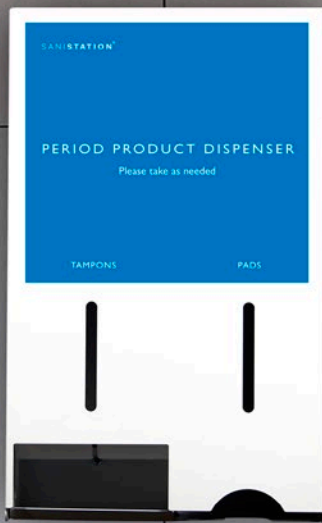

FREE VEND ACCESS TO A RANGE OF PERIOD CARE PRODUCTS HELPS FACILITATE THE INCREASING INDEPENDENCE OF WOMEN AND THEIR ABILITY TO BE ACTIVE AT ALL TIMES OF THE MONTH AND SIMPLY 'CARRY ON WITH LIFE'.

PPD 3

A COMPACT FREE VEND DISPENSER. DISPENSES TAMPONS AND PADS. OR OFFERS A TAMPON, PAD AND LINER COMBINATION. OFTEN LOCATED WITHIN A CUBICLE, OR CENTRALLY WITHIN WASHROOMS WITH LOWER FOOT FALL.

THE SAFE PROVISION OF SANITARY PADS AND TAMPONS.

A compact version of our free-dispense solution that makes sanitary products available in a way that limits cross contamination, waste and theft. The simple dispensing mechanism allows for one pad or tampon to be taken at a time whilst minimising the chance of contaminating the next product in the dispenser. The fully enclosed unit is very easy to clean and complies with all IPC protocols, it's also very quick to assess stock and simple to refill. As with most products in the SaniStation[®] range, the Period Products Dispenser can be branded to suit your healthcare organisation's corporate identity.

- ✓ Space saving design – ideal for use in cubicles
- ✓ Flat top design - ideal for holding mobile phone / keys / handbag
- ✓ Free dispense – no coins or tokens required
- ✓ Simple to install – no electrical supply required
- ✓ Hygienic and easy to clean
- ✓ Minimises cross contamination
- ✓ Complies with all IPC protocols
- ✓ Easy to monitor stock and refill
- ✓ Dispenses a wide range of tampons and pads
- ✓ Reduces waste and theft
- ✓ Robust and secure metal construction
- ✓ Brandable with your logos and messaging
- ✓ Dimensions (mm): 230h x 280w 132d
- ✓ Weight (kg): 3.3kgs

PRODUCT	CODE
Compact Period Products Dispenser	SaniPPD3

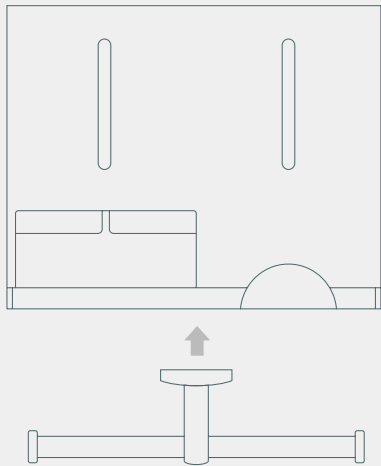

OPTIONS

Optional double toilet roll holder available in stainless steel or chrome finishes

TO CARRY ON WITH LIFE, SHE NEEDS
TO BE EMPOWERED TO CARE
FOR HER NATURAL NEEDS WITH
CONFIDENCE AND CONVENIENCE.

PPD 4

A MULTI-PRODUCT FREE VEND DISPENSER. DISPENSES 2 SIZES OF TAMPON AND PADS, OR OFFERS A TAMPON, PAD AND LINER COMBINATION. OFTEN LOCATED CENTRALLY IN LARGER WASHROOMS WITH HIGH FOOT FALL. THE SAFE PROVISION OF SANITARY PADS AND TAMPONS.

A free-dispense solution that makes up to four different types of sanitary product available in a way that limits cross contamination, waste and theft. The simple dispensing mechanism allows for one pad or tampon to be taken at a time whilst minimising the chance of contaminating the next product in the dispenser. The fully enclosed unit is very easy to clean and complies with all IPC protocols, it's also very quick to assess stock and simple to refill. As with most products in the SaniStation[®] range, the Period Products Dispenser can be branded to suit your healthcare organisation's corporate identity.

- ✓ Dispenses 4 different products offering more choice
- ✓ Free dispense – no coins or tokens required
- ✓ Simple to install – no electrical supply required
- ✓ Hygienic and easy to clean
- ✓ Minimises cross contamination
- ✓ Complies with all IPC protocols
- ✓ Easy to monitor stock and refill
- ✓ Reduces waste and theft
- ✓ Robust and secure metal construction
- ✓ Brandable with your logos and messaging
- ✓ Dimensions (mm): 474h x 280w x 132d
- ✓ Weight (kg): 6.6kgs

PRODUCT	CODE
Multi Period Products Dispenser	SaniPPD4

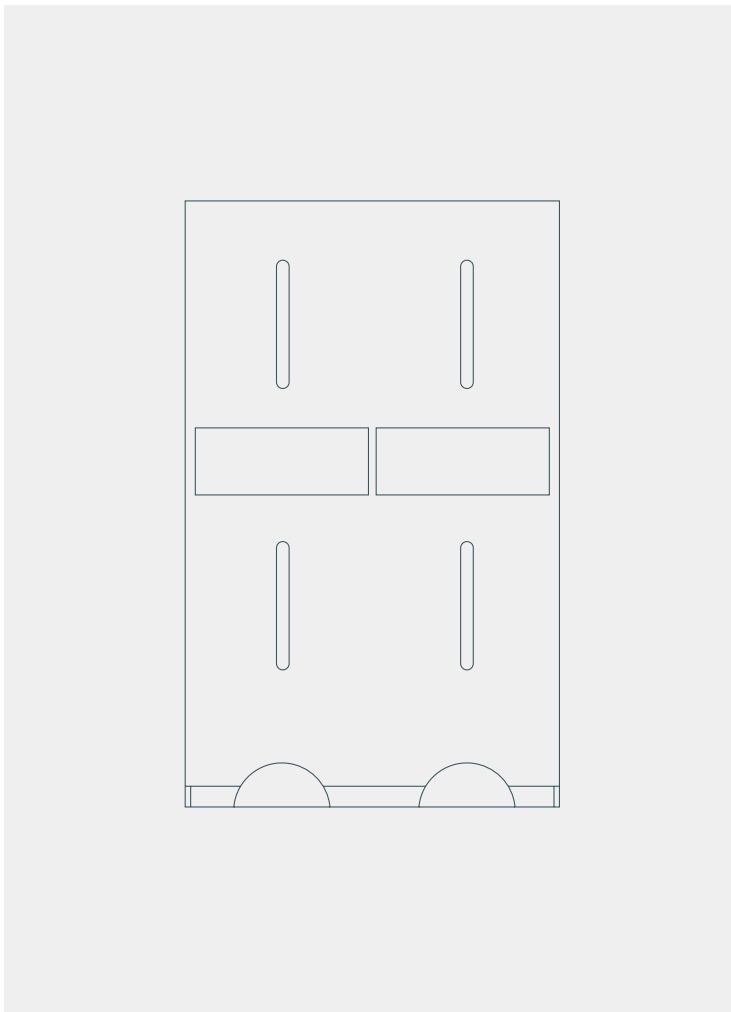
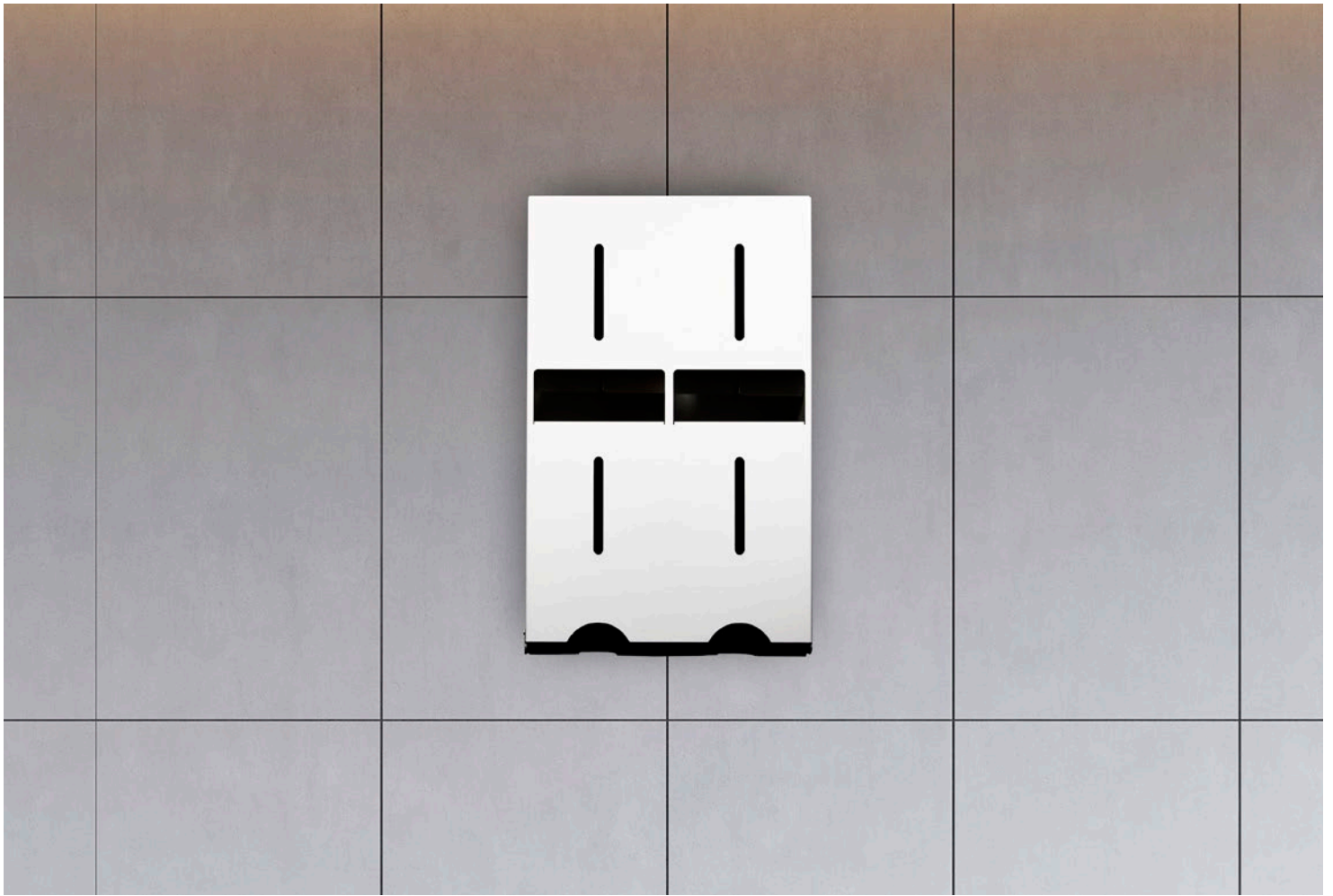

“WHEN DESIGNING AN ENVIRONMENT THAT IS MEANT TO WORK FOR EVERYONE, WE NEED WOMEN IN THE ROOM.”

NOTES

NOTES

FOR MORE INFORMATION

As manufacturers and innovators within the healthcare industry, we're keen and interested to hear from you if you require a solution you haven't seen on our site.

VISIT sani-station.co.uk

CALL +44 (0)345 835 8105

EMAIL info@sani-station.co.uk
